

GV-LPC1100 1.3 MP 3x Zoom B/W Network Camera



- 1.3 megapixel
- 1/3" B/W progressive scan CMOS
- Motorized varifocal lens for remote focus / zoom adjustment
- Dual streams from MJPEG or H.264
- Up to 30 fps at 1280 x 1024
- Maximum speed 120 km/h (75 mph)
- Recognition for reflective License Plate only
- Vandal resistance (IK10 for metal casing)
- Ingress protection (IP67)
- Maximum IR distance 10 m (32.8 ft)
- DC 48V, High PoE (PoE++, 120 W)
- Built-in heater and fan
- Support for TV-out
- Two-way audio
- Support for I/O (1 in / 1 out)
- Defog
- Motion detection
- Privacy mask
- Text Overlay
- IP address filtering
- Supports iPhone, iPad, Android & 3GPP
- ONVIF (Profile S) conformant
- 31 languages on Web interface

Model	GV-LPC1100
Iris	P-Iris
Focal Length	9~22 mm
Horizontal FOV	33°~16°
Maximum Aperture	F/1.2
Image Format	1/2.7"



Introduction

GV-LPC1100 is a 1.3 MP B/W network camera designed for recognition of reflective license plates on vehicles traveling at 120 km/hr (75 mph) or less. With its multiple LEDs and intelligent IR, the camera is able to automatically adjust its shutter speed to the scene and produce clear license plate capture for one lane under low-light conditions. The motorized varifocal lens take the advantage of its motorized focus / zoom in that the user can remotely adjust the focus and zoom through the Web interface. It is weather proof (IP67) and also able to work in environments with temperatures ranging from -40°C (104°F) to 50°C (122°F).

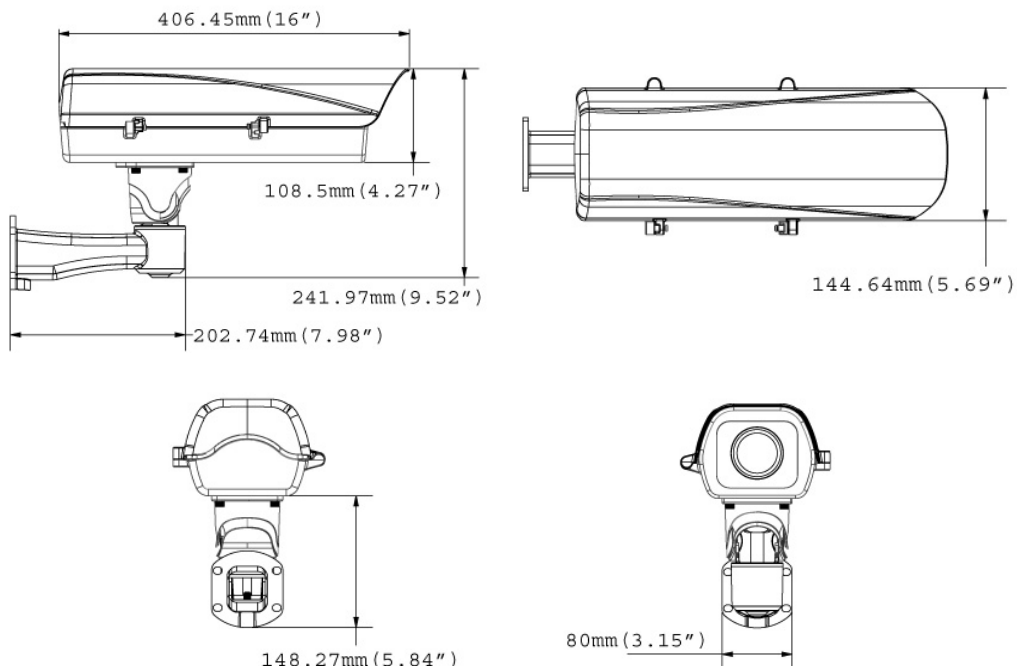
Dimensions



Comparison with other Outdoor GV-IP Cameras

	Headlight Turned On	High Beam Turned On
GV-Hybrid LPR Cam 20R / GV-Hybrid LPR Cam 10R / GV-LPC1100 / GV-IP LPR Cam 5R		
GV-BL1500 Super Low Lux Bullet IP Cam		
GV-BL2400 WDR Pro Bullet IP Cam		

Note: The test results are based on the night scene. All cameras are installed at the distance of 10 m (32.81 ft) from the vehicle, with the resolution set as 1.3 MP and the shutter speed set as 1/2000 sec.





Specifications

Camera		
Image Sensor	1/3" B/W progressive scan CMOS	
Picture Elements	1280 (H) x 1024 (V)	
Shutter Speed	Automatic, Manual (1/500 ~ 1/8000 sec)	
White Balance	Auto / Manual (2800K ~ 8500K)	
S/N Ratio	50 dB	
Max. Speed	120 km/h (75 mph)	
Lens		
Megapixel	1.3 MP	
Lens Type	Motorized varifocal lens	
Focal Length	9 ~ 22 mm	
Horizontal FOV	33°~16°	
Maximum Aperture	F/1.2	
Mount	Ø14 mm	
Image Format	1/2.7"	
Operation	Focus	Auto Focus
	Zoom	3X Optical Zoom
	Iris	P-Iris
IR LED Quantity	4 high power IR LEDs	
IR Distance	8 ~ 10 m (26.2 ~ 32.8 ft)	
Operation		
Video Compression	H.264, MJPEG	
Video Stream	Dual streams from H.264 and MJPEG	
Frame Rate	30 fps at 1280 x 1024 (60/50 Hz) * The frame rate and the performance may vary depending on the number of connections and data bitrates (different scenes)	
Image Setting	Brightness, Contrast, Sharpness, Gamma, Image Orientation, Shutter Speed, Defog	
Audio Compression	G.711, AAC (Optional)	
Audio Support	Two-way audio	
Video Resolution		
Main Stream	4:3	1280 x 960, 640 x 480, 320 x 240
	16:9	1280 x 720, 640 x 360, 448 x 252
	5:4	1280 x 1024 (Default), 640 x 512, 320 x 256
Sub Stream	4:3	640 x 480, 320 x 240
	16:9	640 x 360, 448 x 252
	5:4	640 x 512, 320 x 256 (Default)
TV-Out	NTSC, PAL BNC connector (640 x 480 resolution)	
Network		
Interface	10/100 Base-T Ethernet, RJ-45 connector	
Protocol	DHCP, DynDNS, FTP, HTTP, HTTPS, NTP, ONVIF (Profile S), PSIA, QoS (DSCP), RTSP, SMTP, SNMP, TCP, UDP, UPnP, 3GPP/ISMA	
Mechanical		
Temperature Detector	Yes	
Camera Adjustment	Pan	0° ~ 360°
	Tilt	90° ~ 180°
Connectors	Power	DC 48V, High PoE (PoE++, 120W)
	Ethernet	RJ-45
	Audio	1 In (externally connecting a microphone) / 1 Out (Stereo phone jack, 3.5 mm / 0.14")
	Digital I/O	1 In / 1 Out
	TV-Out	BNC connector (640 x 480 resolution) * The TV-Out function only works in 640 x 480 resolution. For TV-Out to work properly, you must set the video resolution to 1280 x 1024 or lower. If both streams are enabled, the Sub Stream must be set to 640 x 480.
LED Indicator	N/A	

General		
Operating Temperature	-40°C ~ 50°C (-40°F ~ 122°F)	
Humidity	10% ~ 90% (non-condensing)	
Power Source	DC 48V 2.5A, High PoE (PoE++, 120 W)	
Max. Power Consumption	50 W	
Dimensions	Without support rack	406 x 145 x 109 mm (16 x 5.7 x 4.3")
	With rack	3.32 kg
Cable Length	1 m (3.28 ft)	
Weight	With rack	3.32 kg
	Without support rack	2.62 kg
Ingress Protection	IP67	
Vandal Resistance	IK10 for metal casing	
Heater On	-40°C ~ 8°C (-40°F ~ 46.4°F)	
Fan	Constantly On	
Regulatory	CE, FCC, C-Tick, RoHS compliant	
Power over Ethernet		
PoE Standard	High Power Over Ethernet / PD	
PoE Power Supply Type	Mid-Span	
PoE Power Output	DC 48V, 2.5A (120 W Max.)	
Web Interface		
Installation & Management	Web-based configuration	
Firmware Upgrade	Remote upgrade through Web Browser GV-IP Device Utility included in the Software DVD	
Access from Web Browser	Live View, Video Recording, Video Quality, Bandwidth Control, Image Snapshot, Audio, Picture in Picture, Picture and Picture, Privacy Mask, Tampering Alarm, Text Overlay	
Language	Arabic / Bulgarian / Czech / Danish / Dutch / English / Finnish / French / German / Greek / Hebrew / Hungarian / Indonesian / Italian / Japanese / Lithuanian / Norwegian / Persian / Polish / Portuguese / Romanian / Russian / Serbian / Simplified Chinese / Slovakian / Slovenian / Spanish / Swedish / Thai / Traditional Chinese / Turkish	
Applications		
Network Storage	GV-NVR, GV-System, GV-Recording Server	
Smart Device Access	GV-Eye for Android and iOS embedded 3GPP/ISMA browser	
Live Viewing	IE, GV-MultiView	
CMS Server support	GV-Control Center, GV-Center V2, GV-Vital Sign Monitor	
GV-PA482		
PoE Standard	High Power Over Ethernet (PoE++) / PSE	
PoE Power Output	DC 48V, 2.5A (120 W Max.)	
Ethernet Cable Length	Max 100 m (32.8 ft) from GV-PA482 to IP device, CAT5e	
Power Input	AC 100V ~ 240V, 2.5A	
Operating Temperature	-10°C ~ 50°C (14°F ~ 122°F)	
Dimensions (L x W x H)	43 x 69 x 40 mm (1.69 x 2.72 x 1.57")	
Weight	130 g (0.29 lb)	

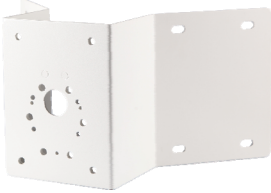
Note: Specifications are subject to change without notice.

Accessories

Model No.	Name		Details
GV-Mount300-1	Convex Corner Adapter Kit		Dimensions: 238.6 x 409.5 mm (9.4 x 16.1") Weight: 4.27 kg (9.41 lb)
GV-Mount310-1	Concave Corner Adapter Kit		Dimensions: 123.3 x 393.1 mm (4.9 x 15.5") Weight: 2.96 kg (6.53 lb)
GV-Mount400-1	Pole Mount Bracket Kit (Ø 4 ~ 6")		Bracket: 241 x 161 mm (9.5 x 6.3") Weight: 1.70 kg (3.75 lb) Steel Strap Diameter: Ø 101 ~ 152 mm (4 ~ 6")
GV-Mount410-1	Pole Mount Bracket Kit (Ø 6 ~ 7.5")		Bracket: 241 x 161 mm (9.5 x 6.3") Weight: 1.70 kg (3.75 lb) Steel Strap Diameter: Ø 152 ~ 191 mm (6 ~ 7.5")
GV-PA482 PoE Adapter	The GV-PA482 PoE adapter is designed to provide power and network connection over a single Ethernet cable.		
GV-POE Switch	The GV-POE Switch is designed to provide power along with network connection for IP devices. The GV-POE Switch is available in various models with different numbers and types of ports.		
GV-Relay V2		The GV-Relay V2 is designed to expand the voltage load of GV IP devices. It provides 4 relay outputs, and each can be set as normally open (NO) or normally closed (NC) independently as per your requirement.	

Packing List

- The GV-LPC1100 camera
- Screw Anchor x 4
- Screw x 4
- Washer x 4
- Torx Wrench x 1
- GV-PA482 PoE Adapter
- Power Adapter (DC 48V, 2.5A, 120 W)
- AC Power Cord
- Silica Gel Bag x 1
- Adhesive tape for Silica Gel Bag x 1
- Download Guide
- GV-LPR Camera Installation Guide